





## SANUTAL unité de ventilation type D

AIR<sup>2</sup> | AIR<sup>3</sup> | AIR<sup>4</sup> | AIR<sup>5</sup>

		
N° article	99.SAIR2HR	99.SAIR3HR
Article selon EPBD	AIR2 (HR)	AIR3 (HR)
Tension	230 VAC	230 VAC
Fréquence	50 Hz	50 Hz
Débit maximum (Qmax) 200 Pa	250 m <sup>3</sup> /h	310 m <sup>3</sup> /h
Valeur SPI	0,217 W/(m <sup>3</sup> /h)	0,255 W/(m <sup>3</sup> /h)
Débit reference	175m <sup>3</sup> /h - 0,0486m <sup>3</sup> /s	238m <sup>3</sup> /h - 0,066m <sup>3</sup> /s
Niveau de pression acoustique **	46 dB(A)	51 dB(A)
Puissance maximum	2 x 85 W	2 x 85 W
Pression max par reference 200 Pa	2 x 51 W	2 x 85 W
Efficacité selon EN 13141-7	86 %	85 %
Type commande ventilateur	Débit constant	Débit constant
Type ventilateur	EC	EC
Bypass automatique	Oui	Oui
Connection USB	Oui	Oui
Connection 0-10 volt	Oui	Oui
Application smartphone	iOS / Android	iOS / Android
Commande 4 position	Option	Option
CO2-sensor extern	Option	Option
Filtration (ISO COARSE 60%)	G4 (Option F7)	G4 (Option F7)
Notification de filtre	Oui	Oui
Montage	Plafond et mural	Plafond et mural
Raccordement	Ø 180	Ø 180
Dimensions boîtier (LxBxH)	1160x725x300 mm	1160x725x300 mm
Pois de l'appareil	17 kg	17 kg

\*\* par débit reference (70% Qmax à 50Pa)

		
N° article	99.SAIR4	99.SAIR5
Tension	230 VAC	230 VAC
Fréquence	50 Hz	50 Hz
Débit maximum (Qmax) 200Pa	450 m <sup>3</sup> /h	550 m <sup>3</sup> /h
Valeur SPI	0,224 W/(m <sup>3</sup> /h)	0,270 W/(m <sup>3</sup> /h)
Débit reference	315m <sup>3</sup> /h - 0,0875m <sup>3</sup> /s	385m <sup>3</sup> /h - 0,107m <sup>3</sup> /s
Niveau de pression acoustique	53 dB(A) 410 m <sup>3</sup> /h à 200Pa	58 dB(A) 550 m <sup>3</sup> /h à 200Pa
Puissance maximum	2 x 170 W	2 x 170 W
Pression max par reference 200 Pa	2 x 110 W	2 x 170 W
Efficacité selon EN 13141-7	83 %	83 %
Type commande ventilateur	Débit constant	Débit constant
Type ventilateur	EC	EC
Bypass automatique	Oui	Oui
Connection USB	Oui	Oui
Connection 0-10 volt	Oui	Oui
Application smartphone	iOS / Android	iOS / Android
Commande 4 position	Option	Option
CO <sub>2</sub> -sensor extern	Option	Option
Filtration (ISO COARSE 60%)	G4 (Option F7)	G4 (Option F7)
Notification de filtre	Oui	Oui
Montage	Plafond et mural	Plafond et mural
Raccordement	Ø 180	Ø 180
Dimensions boîtier (LxBxH)	1160x725x438 mm	1160x725x438 mm
Pois de l'appareil	22 kg	22 kg

Dimensions

**AIR<sup>2</sup>** | **AIR<sup>3</sup>**

**AIR<sup>4</sup>** | **AIR<sup>5</sup>**

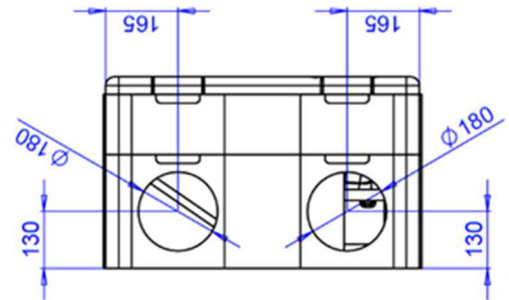
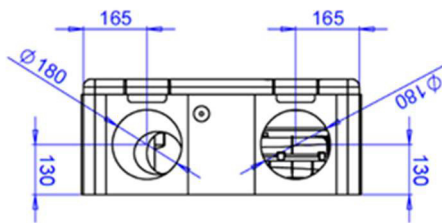
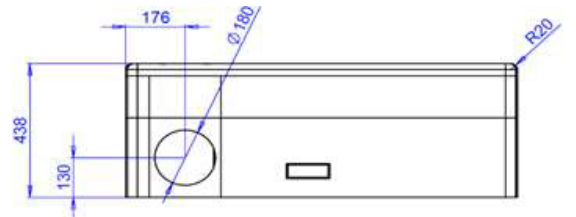
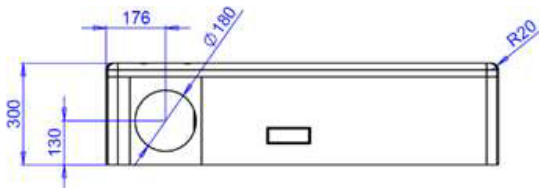
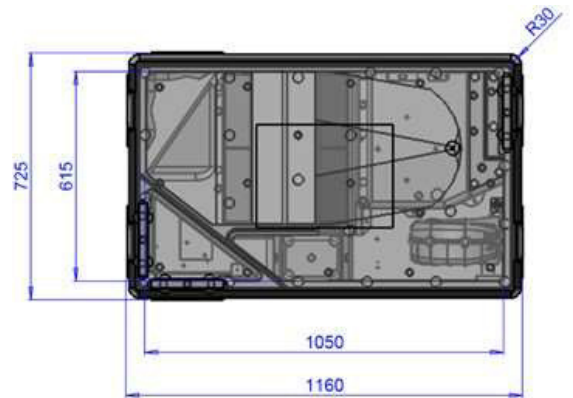
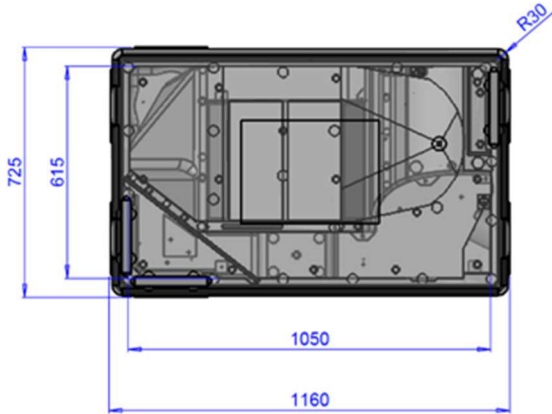

Débit

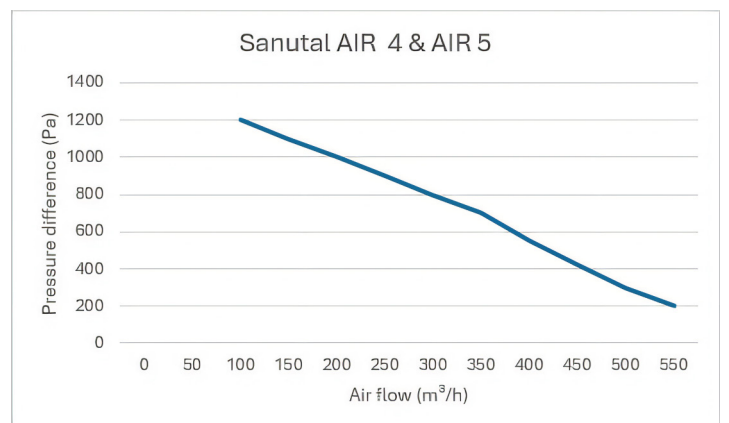
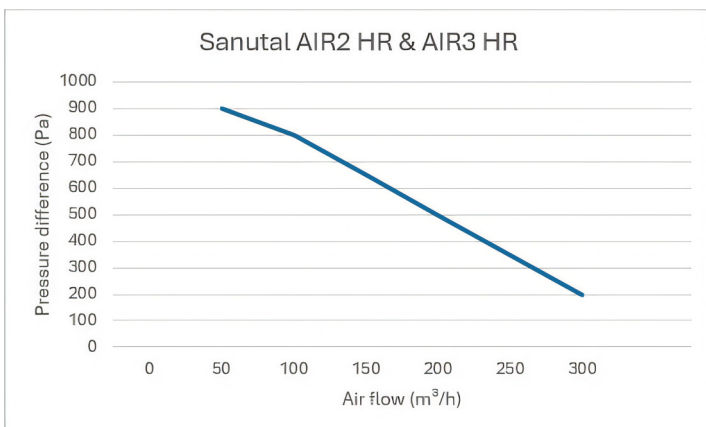

Puissance

AIR2 HR

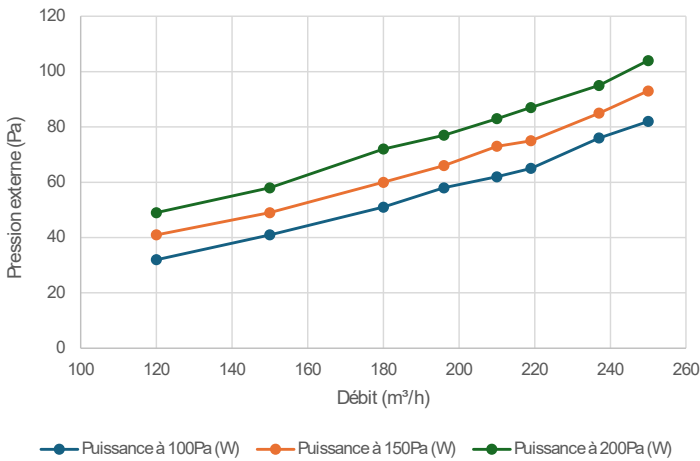

AIR3 HR

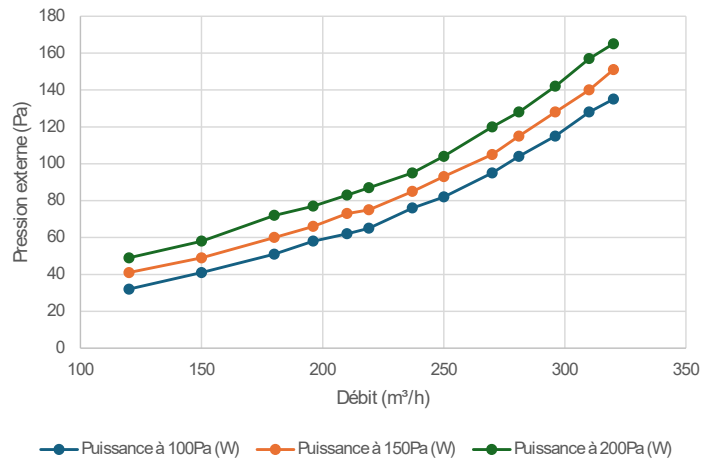

AIR4

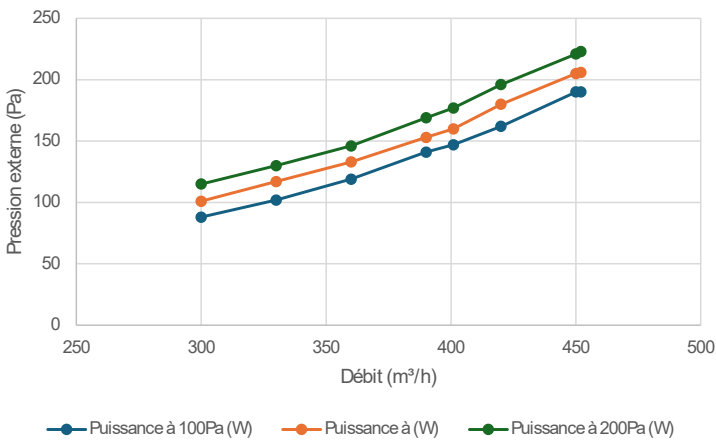

AIR5

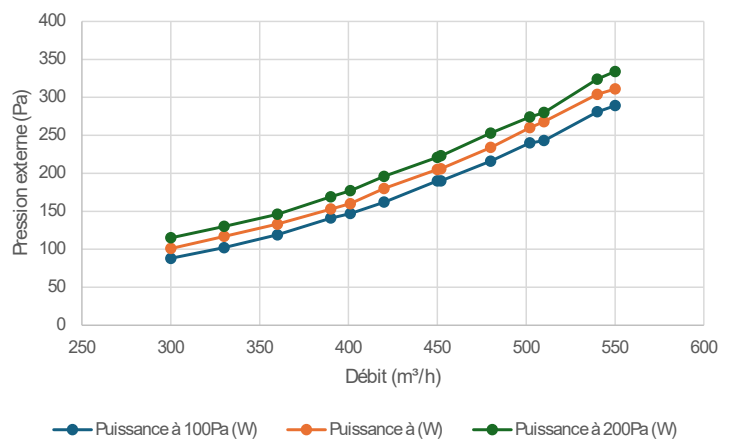

## Efficacité EPBD

Debit	AIR 2	AIR 3	AIR 4	AIR 5
196 m <sup>3</sup> /h	86%			
237 m <sup>3</sup> /h	85%	85%		
237 m <sup>3</sup> /h	84%	84%		
281 m <sup>3</sup> /h		83%		
296 m <sup>3</sup> /h		82%		
400 m <sup>3</sup> /h			83%	83%
450 m <sup>3</sup> /h			82%	82%
500 m <sup>3</sup> /h				81%
550 m <sup>3</sup> /h				80%